

# 150T-3 BIG WHEEL ( Europell、 front disc brake, rear drum brake, case lengthen ) PARTS LIST



图1 曲轴箱总成

FIG.1 CRANKCASE COMP

型号 TOTAL NO	序号 NO	零部件件号	零件编号 PQRT NO	英文名称
				ENGLISH NAME
HS1P57QMJ	1	11100-F22B-0000	T1101	CRANKCASE ASSY L
HS1P57QMJ	2	11102-F21-0000	T1102	BUSH ENGINE HABGER RUBBERΦ28
HS1P57QMJ	3	91212-F21-0000	T1103	GASKET CRAKCASE
HS1P57QMJ	4	11103-F21-0000	T1201	BUSH RR CUSHION UNDER RUBBERΦ20
HS1P57QMJ	5	91101-F21-0000	T1205	OIL SEAL Φ19.8*30*5
HS1P57QMJ	6	91102-F21-0000	T1206	OIL SEAL Φ27*42*7
HS1P57QMJ	7	16674	T1207	BEARING RADLAL BALL 6002
HS1P57QMJ	8	6177,2	T1208	BEARING RADLAL BALL 6004
HS1P57QMJ	9	276-6301	T1209	BEARING RADLAL BALL 6301
HS1P57QMJ	10	11200-F21-0000	T1221	CRANKCASE ASSY R
HS1P57QMJ	11	18602-F21-0000	T1228	TUBE BREATHER
HS1P57QMJ	12	90031-F21-0000	125-T0010-011	BOLT STUP 8*187.5
HS1P57QMJ	13	90032-F21-0000	125-T0010-011	BOLT STUP 8*195.5
HS1P57QMJ	14	90801-F21-0000	125-T0010-016	PIN DOWEL Φ8*14
HS1P57QMJ	15	5787-6-50	GB/T5787-86	BOLT FLANGE 6*50
HS1P57QMJ	16	6187-8-00	GB/T6187-2000	NUT FLANCE M8
HS1P57QMJ	17	96-	GB/T96-85	WASHER DRAIN PLUG Φ12MM
HS1P57QMJ	18	15.12.5790	125-T0010-012	BOLT DRAIN PLUG M12
HS1P57QMJ	19	97.1-12-00	GB/T97.1-85	WASHER DRAIN PLUG Φ12MM
HS1P57QMJ	20	14300-F21-0000	T1318	CHAIN CAM
HS1P57QMJ	21	14520-F21-0000	T1326	TENSIONER CAM CHAIN
HS1P57QMJ	22	14630-F21-0000	T1327	GUIDE COMP CAM CHAIN
HS1P57QMJ	23	14500-F21-0000	T1328	LIFTER ASSY TENSIONER
HS1P57QMJ	24	91205-F21-0000	T1329	O-RING Φ9.5*1.5
HS1P57QMJ	25	14521-F21-0000	T1331	PIVOT CAM CHAIN TENSIONER
HS1P57QMJ	26	91206-F21-0000	T1339	O-RING Φ15*1.5
HS1P57QMJ	27	91218-F21-0000	T1341	GASKET TENSIONER LIFTER
HS1P57QMJ	28	22.06.5787	GB/T5787-86	IBOLT FLANGE M6*22

HS1P57QMJ	29	818-6-6	GB/T818-88	CSCREW PAN M6*6
-----------	----	---------	------------	-----------------

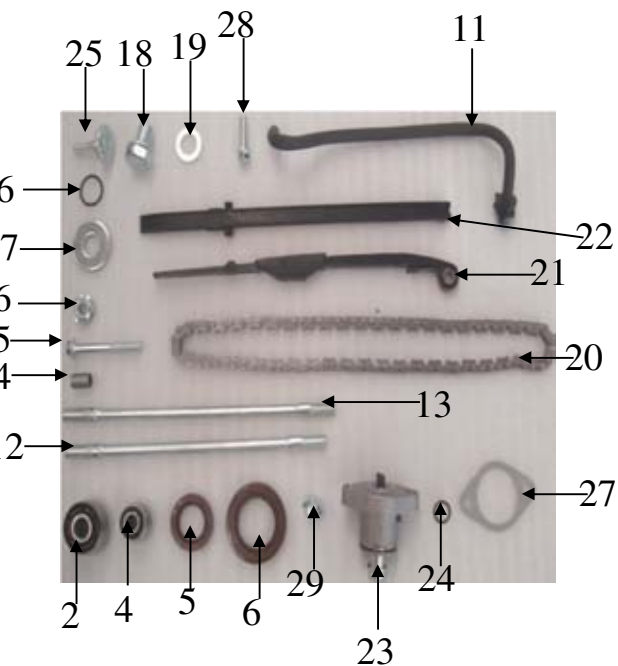
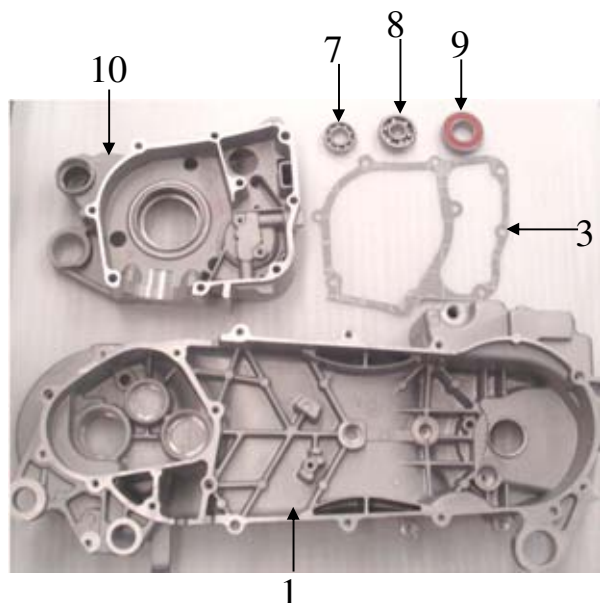
图2 变速箱盖总成

FIG.2 GEAR-BOX COVER ASSY.

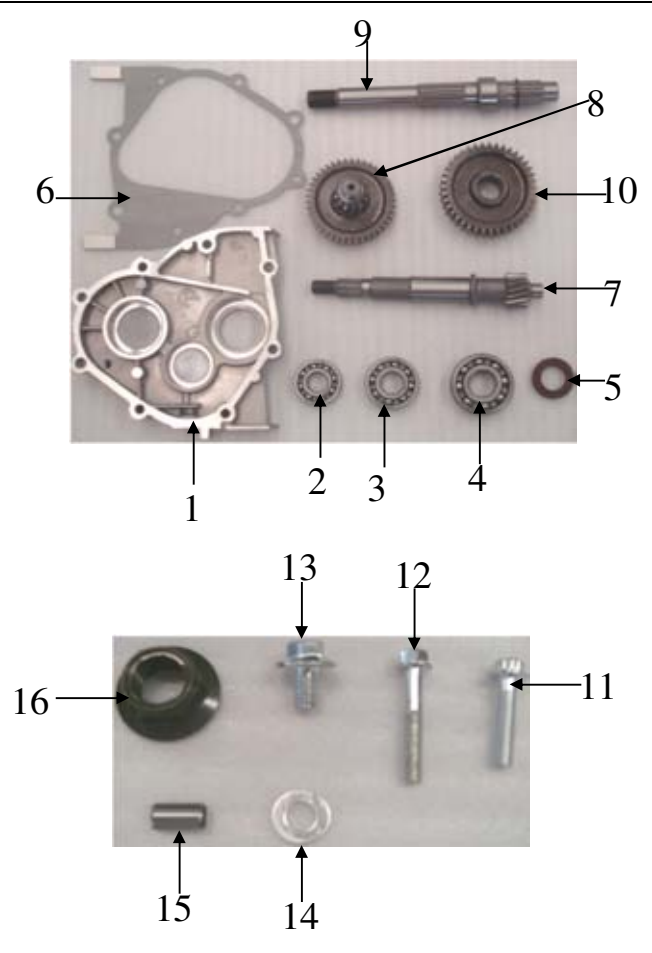

型号 TOTAL NO	序号 NO	图号	零件编号 PQRT NO	英文名称
				ENGLISH NAME
HS1P57QMJ	1	22700-F21-0000	T1701	COVER MISSION ASSY
HS1P57QMJ	2	276-6202	T1702	BEARING RADLAL BALL 6202
HS1P57QMJ	3	276-6203	T1703	BEARING RADLAL BALL 6203
HS1P57QMJ	4	276-6204	T1704	BEARING RADLAL BALL 6204
HS1P57QMJ	5	91103-F21-0000	T1706	OIL SEAL $\Phi 20 \times 32 \times 6$
HS1P57QMJ	6	91221-F21-0000	91211-F21-0000	GASKET MISSION COVER
HS1P57QMJ	7	22701-F21-0000	T2001	SHAFT DRIVE
HS1P57QMJ	8	22702-F21-0000	T2002	SHAFT COMP COUNTER
HS1P57QMJ	9	22703-F21-0000	T2003	SHAF FINAL
HS1P57QMJ	10	22704-F21-0000	T2004	GEAR FINAL
HS1P57QMJ	11	28.06.5787	GB/T5787-86	BOLT FLANGE 6*28
HS1P57QMJ	12	5787-6-35	GB/T5787-86	BOLT FLANGE 6*35
HS1P57QMJ	13	12.08.5787	GB/T5787-86	BOLT SPECLAL M8*20
HS1P57QMJ	14	97.1-8	GB/T97.1-85	WASHER $\Phi 8 \text{MM}$
HS1P57QMJ	15	90801-F21-0000	125-T0010-016	PIN DOWEL $\Phi 8 \times 14$
HS1P57QMJ	16	6187-16-00	GB/T6187-2000	NUT M16

图3 左盖总成

FIG.3 L. COVER COMP.

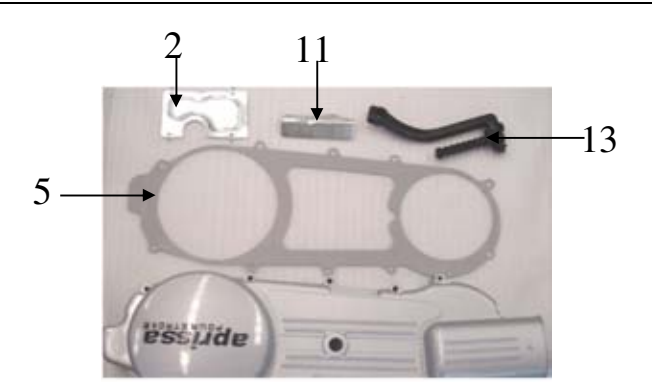

型号 TOTAL NO	序号 NO	图号	零件编号 PQRT NO	英文名称
				ENGLISH NAME
HS1P57QMJ	1	11300-F22B-0000	T1222	COVER L
HS1P57QMJ	2	11301-F21-0000	T1223	PLATE L COVER
HS1P57QMJ	3	91501-F21-0000	T1224	CLAMPER BRAKE CABLE
HS1P57QMJ	4	91502-F21-0000	T1225	CLAMPER BRATHER DRAIN TUBE

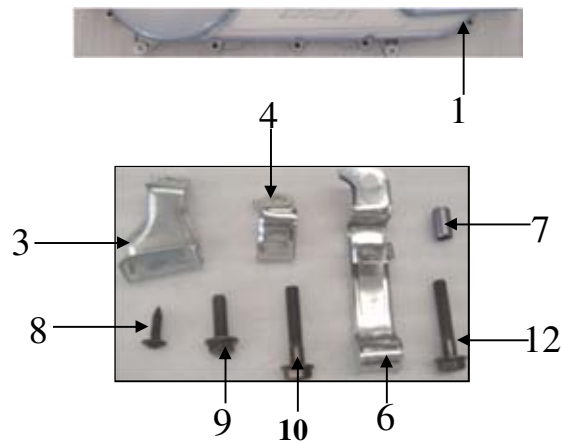

HS1P57QMJ	5	91214-F22B-0000	T1227	GASKET L COVER
HS1P57QMJ	6	91504-F21-0000	T1229	CLAMPER THROTTLE CABLE
HS1P57QMJ	7	90801-F21-0000	125-T0010-016	PIN DOWEL $\Phi 8*14$
HS1P57QMJ	8	845-3.8-8	GB/T845-85	SCREW TAPPINGST3.8*8
HS1P57QMJ	9	5787-6-40	GB/T5787-86	BOL FLANGE 6*40
HS1P57QMJ	10	5787-6-45	GB/T5787-86	BOL FLANGE 6*45
HS1P57QMJ	11	91511-F21-0000	T2122	BLOCK, MAIN STAND
HS1P57QMJ	12	5787-6-65	GB/T5787-86	BOL FLANGE 6*65
HS1P57QMJ	13	21900-F21-0000	T2033	LEVER.ASSY.KICK STARTER

图 4 右箱体端盖总成

FIG.4 RIGHT CRANKCASE COVER COMP.

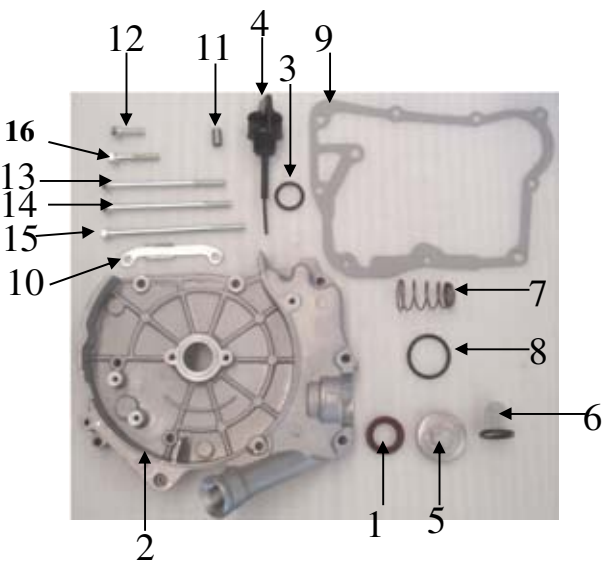

型号 TOTAL NO	序号 NO	图号	零件编号 PQRT NO	英文名称
				ENGLISH NAME
HS1P57QMJ	1	91101-F21-0000	T1205	OIL SEAL 19.8*30*5
HS1P57QMJ	2	11400-F21-0000	T1213	COVER R CRANKCASE COMP
HS1P57QMJ	3	91202-F21-0000	T1214	O-RING $\Phi 18*3$
HS1P57QMJ	4	15214-F21-0000	T1215	GAUGE OIL LEVEL
HS1P57QMJ	5	15212-F21-0000	T1216	CAP TAPPET ADJUSTING HOLE
HS1P57QMJ	6	15211-F21-0000	T1217	SCREEN OIL FILTER SCREEN
HS1P57QMJ	7	15213-F21-0000	T1218	SPRING OIL FILTER SCREEN
HS1P57QMJ	8	91203-F21-0000	T1219	O-RING $\Phi 30.8*3mm$
HS1P57QMJ	9	91213-F21-0000	T1226	GASKET R CRANKCAE COVER
HS1P57QMJ	10	91510-F21-0000	T2114	CLAMPER A.C.GENERATOR CORD
HS1P57QMJ	11	90801-F21-0000	125-T0010-016	PIN DOWEL $\Phi 8*14$
HS1P57QMJ	12	28.06.5787	GB/T5787-86	BOLT FLANGE M6*28
HS1P57QMJ	13	5787-6-95	GB/T5787-86	BOLT FLANGEM6*95
HS1P57QMJ	14	5787-6-100	GB/T5787-86	BOLT FLANGEM6*100
HS1P57QMJ	15	5787-6-110	GB/T5787-86	BOLT FLANGE M6*110
HS1P57QMJ	16	5787-6-35	GB/T5787-86	BOLT FLANGE M6*35

图5 气缸体总成

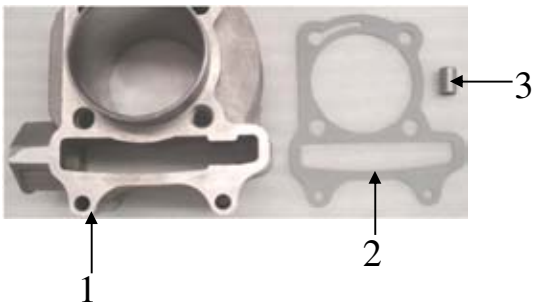

FIG.5 CYLINDER COMP.

型号 TOTAL NO	序号 NO	图号	零件编号 PQRT NO	英文名称
				ENGLISH NAME
HS1P57QMJ	1	12100-F22-0000	1P57QMJ-1301	CYLINDER COMP
HS1P57QMJ	2	91215-F22-0000	1P57QMJ-1302	CASKET CYLINDER
HS1P57QMJ	3	90802-F21-0000	125-T0010-016	PIN DOWEL $\Phi 10*16$



图6 气缸头总成

FIG.6 CYLINDER HEAD ASSY.

型号 TOTAL NO	序号 NO	图号	零件编号 PQRT NO	英文名称
				ENGLISH NAME
HS1P57QMJ	1	12200-F22-0000	1P57QMJ-1303	HEAD COPM CYLINDER
HS1P57QMJ	2	91216-F22-0000	1P57QMJ-1304	GASKET CYLINDER HEAD
HS1P57QMJ	3	33300-F21-0000	T1304	PLUG SPARK ( A7RTC NGK )
HS1P57QMJ	4	91219-F21-0000	T1501	COVER
HS1P57QMJ	5	91220-F21-0000	T1502	INSULATOR , IN PIPE
HS1P57QMJ	6	14800-F21-0000	T1503	INSULATOR COPM , CARBURETOP
HS1P57QMJ	7	14801-F21-0000	T1504	DUSTPROOF COVER, INLET PIPE
HS1P57QMJ	8	899-6-32	125-T0010-011	BOLT , SPECLAL STUD , 6*32
HS1P57QMJ	9	899-6-63	125-T0010-011	BOLT , SPECLAL STUD , 6*63
HS1P57QMJ	10	6177.1-6-00	GB/T6177.1-86	NUT FLANGE 6mm
HS1P57QMJ	11	6177.1-8-00	GB/T6177-.186	NUT FLANGE 8mm
HS1P57QMJ	12	90802-F21-0000	125-T0010-016	PIN DOWEL $\Phi 10*16$
HS1P57QMJ	13	5787-6-100	GB/T5787-86	BOLT FLANGE 6*100
HS1P57QMJ	14	91104-F21-0000	T1305	SEAL VALVE STME $\Phi 27*25*10.6*6.7*8.4$
HS1P57QMJ	15	12250-F21-0000	T1310	BRACKET,SEAT FIXUP
HS1P57QMJ	16	13120-F22-0000	T1317	CAMSHAFT COMP
HS1P57QMJ	17	14751-F21-0000	T1334	SPRING VALVE OUTER
HS1P57QMJ	18	14761-F21-0000	T1335	SPRING VALVE INTER
HS1P57QMJ	19	14771-F21-0000	T1336	RETAINER VALVE SPRING



HS1P57QMJ	20	14775-F21-0000	T1337	SEAT VALVE SPRING OUTER
HS1P57QMJ	21	14781-F21-0000	T1338	COTTER VALVE
HS1P57QMJ	22	14711-F22-0000	1P57QMJ-1332	VALVE IN
HS1P57QMJ	23	14721-F22-0000	1P57QMJ-1333	VALVE EX

图7 气缸头盖总成

FIG.7 CYLINDER HEAD COVER COMP

型号 TOTAL NO	序号 NO	图号	零件编号 PQRT NO	英文名称 ENGLISH NAME
HS1P57QMJ	1	18601-F21-0000	T1211	
HS1P57QMJ	2	12310-F21-0000	T1311	
HS1P57QMJ	3	12391-F21-0000	T1314	
HS1P57QMJ	4	91504-F21-0000	T1312	
HS1P57QMJ	5	16674-6-25	GB5787-86	
HS1P57QMJ	6	91505-F21-0000	T1313	
HS1P57QMJ	7	12311-F21-0000	T1320	
HS1P57QMJ	8	12312-F21-0000	T1321	
HS1P57QMJ	9	16674-6-32	GB5787-86	
HS1P57QMJ	10	12313-F21-0000	T1309	
HS1P57QMJ	11	12314-F21-0000	T0010-002	
HS1P57QMJ	12	12315-F21-0000	T1307	
HS1P57QMJ	13	12316-F21-0000	T1308	
HS1P57QMJ	14	16674-6-25	GB5787-86	



图8 曲轴连杆组件、活塞组件

FIG.8 CRANKCASE SHAFT, PISTON COMP

型号 TOTAL NO	序号 NO	图号	零件编号 PQRT NO	英文名称 ENGLISH NAME
HS1P57QMJ	1	13200-F21-0000	T1319	CRANKSHAFT COMP
HS1P57QMJ	2	13120-F22-0000	1P57QMJ-1321	RING SET PISTON ( STD )



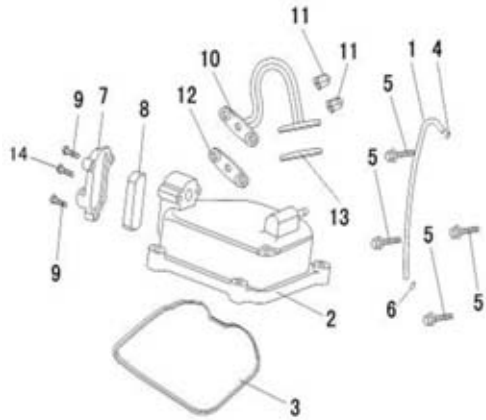
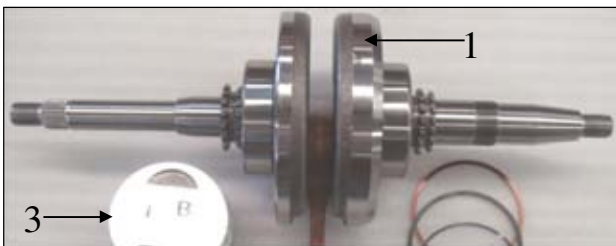



HS1P57QMJ	3	13100-F22-0000	1P57QMJ-1322	RISTON ( STD )
HS1P57QMJ	4	13111-F22-0000	1P57QMJ-1323	PIN PISTON
HS1P57QMJ	5	91301-F21-0000	T1325	CLIP PISTON PIN Φ15MM



图9 电起动部件

FIG.9 ELECTRIC STARTING ASSY

型号 TOTAL NO	序号 NO	图号	零件编号 PQRT NO	英文名称 ENGLISH NAME
HS1P57QMJ	1	24401-F21-0000	T2101	GEAR STARTER REDUCTION
HS1P57QMJ	2	24402-F21-0000	T2102	SHAFI STARTER REDUCTION GEAR
HS1P57QMJ	3	24300-F22-0000	1P57QMJ-2010	OUTER COMP STARTING CLUTCH
HS1P57QMJ	4	31200-F21-0000	T2111	MOTOR ASSY STARER
HS1P57QMJ	5	16.06.5787	GB/T5787-86	BOLT RLANGE 6*16
HS1P57QMJ	6	31202-F21-0000	125-T0010-013	NUT LOCK 22MM
HS1P57QMJ	7	96-	GB/T96-85	WASHER THRUST Φ22.2*31*2.5

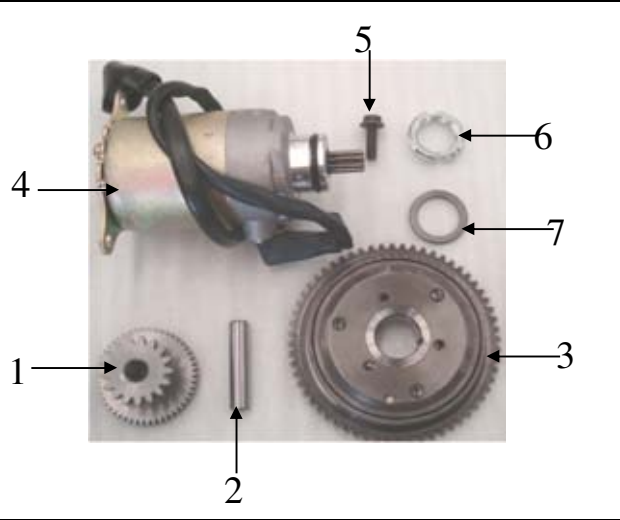

图10 驱动轮总成

FIG.10 DRIVE GEAR ASSY

型号 TOTAL NO	序号 NO	图号	零件编号 PQRT NO	英文名称 ENGLISH NAME
HS1P57QMJ	1	21390-F21-0000	T1203	BAFFLE STARTER LEVER SPRING
HS1P57QMJ	2	21607-F21-0000	T2011	GEAR KICK DRIVEN ( 20T )
HS1P57QMJ	3	21600-F21-0000	T1810	DRIVE GEAR ASSY
HS1P57QMJ	4	21700-F21-0000	T2020	GEAR COMP STARTER IDLE ( 13T/49T )
HS1P57QMJ	5	21800-F21-0000	T2030	SPINDLE COMP KICK STARTER
HS1P57QMJ	6	14.06.5787	GB/T5787-86	BOLT FLABGE M6*14
HS1P57QMJ	7	97.1-12-00	GB/T97.1-85	WASHER PLWIN Φ12MM
HS1P57QMJ	8	6177.1-12-00	GB/T6177.1-2000	NUT FLANGE M12

图11 从动轮皮带总成

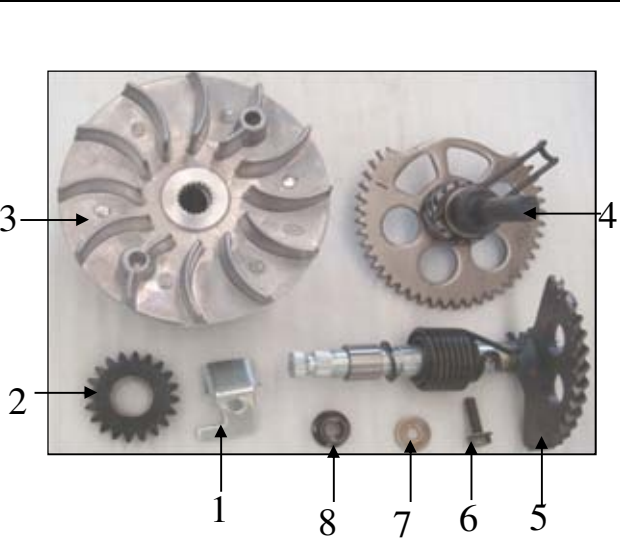
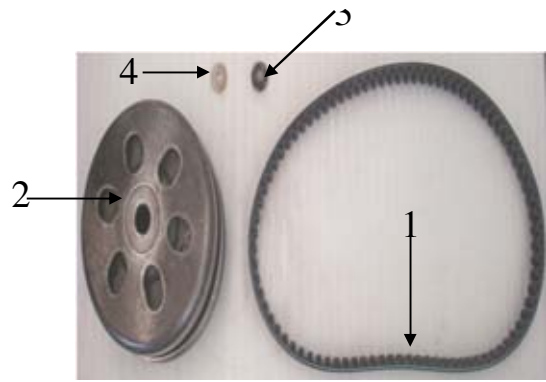

FIG.11 FACE ASSY DRIVEN

型号 TOTAL NO	序号 NO	图号	零件编号 PQRT NO	英文名称
				ENGLISH NAME
HS1P57QMJ	1	21202-F22B-0000	T1901	BELT DRIVE
HS1P57QMJ	2	21100-F21-0000	T1910	FACE ASSY DRIVEN
HS1P57QMJ	3	6177.1-12-00	GB/T6177.1-2000	NUT COMPRESSOR FLANGE 12MM
HS1P57QMJ	4	97.1-12-00	GB/T97.1-85	WASHER PLAIN Φ12MM



图12 磁电机总成

FIG.12 MAGNETO ASSY

型号 TOTAL NO	序号 NO	图号	零件编号 PQRT NO	英文名称
				ENGLISH NAME
HS1P57QMJ	1	19110-F21-0000	T1601	PAN COMP COOLING
HS1P57QMJ	2	31100-F21-0000	T2110	CENERATOR ASSY FLYWHEEL A.C
HS1P57QMJ	3	97.1-12-00	GB/T97.1-85	WASHER PLANI Φ12MM
HS1P57QMJ	4	21-5-12	GB/T21-1976	BOLT HEX M5*12
HS1P57QMJ	5	6177.1-12-00	GB/T6177.1-2000	NUT FLANGE M12
HS1P57QMJ	6	18.06.5787	GB/T5787-86	BOLT FLANGE M6*18
HS1P57QMJ	7	25.06.5787	GB/T5787-86	BOLT FLANGE M6*25

图13 导风罩

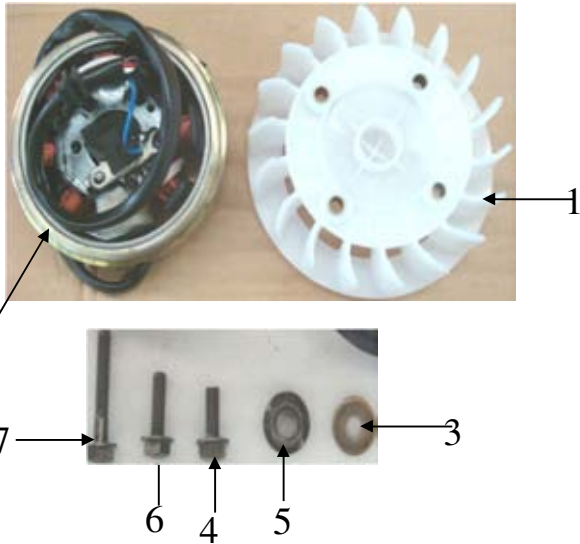
FIG.13 SHROUD COMP



型号 TOTAL NO	序号 NO	图号	零件编号 PQRT NO	英文名称
				ENGLISH NAME
HS1P57QMJ	1	19101-F21-0000	T1602	COVER COMP FAN
HS1P57QMJ	2	19103-F21-0000	T1603	SHROUD A
HS1P57QMJ	3	19106-F21-0000	T1604	SHROUD COMP B
HS1P57QMJ	4	19102-F21-0000	T1605	CUCT CARBUETTOR COOLING
HS1P57QMJ	5	91508-F21-0000	T1606	CLIP HIGH TENSION CORD

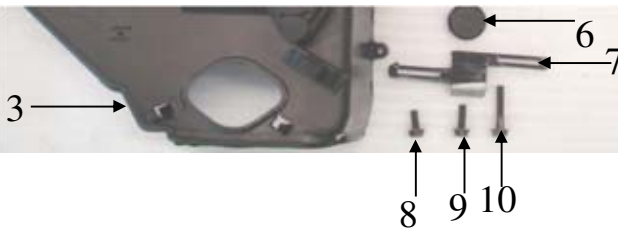

HS1P57QMJ	6	19108-F21-0000	T1607	CROMMET B SIDE PANEL
HS1P57QMJ	7	91509-F21-0000	T2113	CLAMPERS STARTER CABLE
HS1P57QMJ	8	21-5-12	GB/T21-1976	SCREW TAPPING 5*12
HS1P57QMJ	9	845-5-16	GB/T845-85	SCREW TAPPING 5*16
HS1P57QMJ	10	25.06.5787	GB/T5787-86	BOLT FLANGE 6*25



图14 机油泵组合

FIG.14 OIL PUMP ASSY.

型号 TOTAL NO	序号 NO	图号	零件编号 PQRT NO	英文名称
				ENGLISH NAME
HS1P57QMJ	1	15100-F21-0000	T1410	PUMP ASSY OIL
HS1P57QMJ	2	15003-F21-0000	T1411	SPROKET OIL PUMP
HS1P57QMJ	3	15002-F21-0000	T1412	CHAIN OIL PUMP
HS1P57QMJ	4	15001-F21-0000	T1413	SEPARATOR OIL
HS1P57QMJ	5	6177.1-6-00	GB/T6177.1-86	BOLT FLANGE, 6
HS1P57QMJ	6	25.06.5787	GB/T5787-86	BOLT FLANGE, 6*25
HS1P57QMJ	7	12.06.5787	GB/T5787-86	BOLT FLANGE, 6*12

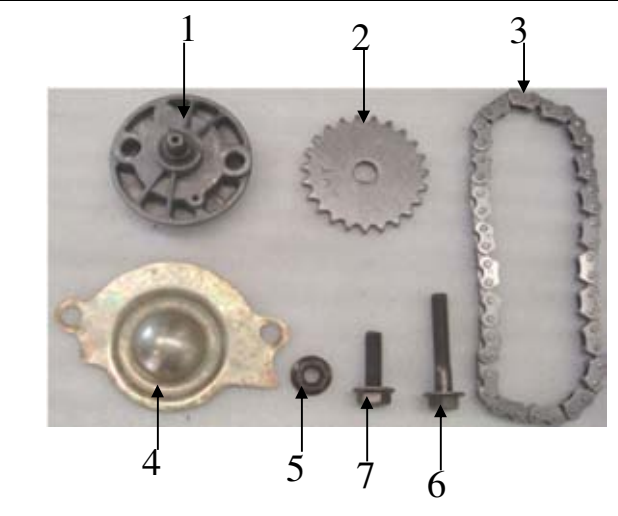

图15 后制动蹄块

FIG.15 CARBURETOR

型号 TOTAL NO	序号 NO	图号	零件编号 PQRT NO	英文名称
				ENGLISH NAME
HS1P57QMJ	1	42203-F21-0000	T2115	BAFFLE ,REAR BRAKE ROCKER
HS1P57QMJ	2	42204-F21-0000	T2116	DUSTPROOF COVER ,REAR BRAKE ROCKER
HS1P57QMJ	3	42205-F21-0000	T2118	SPRING ,REAR BRAKE ROCKER
HS1P57QMJ	4	42202-F22B-0000	T2123	SPRING SHOE ,REAR BRAKE ROCKER
HS1P57QMJ	5	6187-8-00	GB/T 6187-86	NUT ,STEMLOCK,8
HS1P57QMJ	6	91211-F21-0000	T2125	O-RONG,Φ11.3*1.3
HS1P57QMJ	7	91104-F21-0000	42205-062-0001	PIN,BRAKE
HS1P57QMJ	8	5787-6-32	GB/T5787-86	BOLT,HANG,M6*32
HS1P57QMJ	9	42207-F21-0000	T2121	ARM,RR.BRAKE



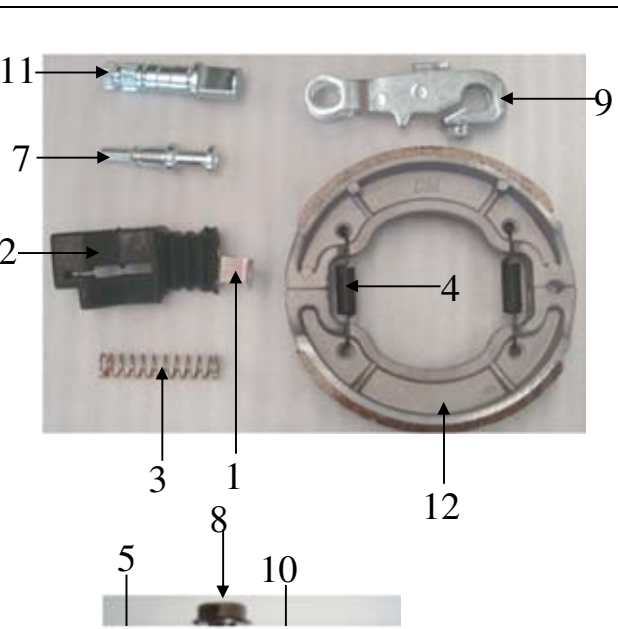
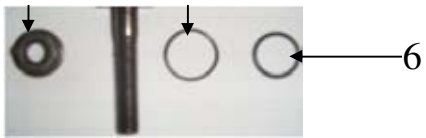

HS1P57QMJ	10	91210-F21-0000	T2124	O-RONG,Φ13.1*10
HS1P57QMJ	11	42206-F21-0000	T2119	CAMSHAFT,RR.BRAKE
HS1P57QMJ	12	42201-F22B-0000	T2117	SHOEASSY.,RR.BRAKE



图16 化油器

FIG.16 CARBURETOR

型号 TOTAL NO	序号 NO	图号	零件编号 PQRT NO	英文名称 ENGLISH NAME
HS150T-3	1	16100-145-0200	150T-T0040	CARBURETOR
				Vergaser-Membran



图17 前面板

Front cover

型号 TOTAL NO	序号 NO	图号	零件编号 PQRT NO	英文名称 ENGLISH NAME
HS150T-3	1	35100-062-0200	150T3-13010	Headlight
HS150T-3	2	82116-062-0000	150T3-12002	Windows crew
HS150T-3	3	82111-062-0000	150T3-12001	Front cover
HS150T-3	4	818-6-16	GB/T818-88	Bolt M6×16
HS150T-3	5	845-4.2-16	GB845-85	self-tapping screw ST4.2×16
HS150T-3	6	845-4.8-16	GB845-85	self-tapping screw ST4.8×16
HS150T-3	7	18502-145-0000	125T-T0015	VENTILATE PIPE
HS150T-3	8	18510-145-0000	125T-T0016	THROTTLE
HS150T-3	9	90403-145-0000	125T-T0017	PIPE HOOP

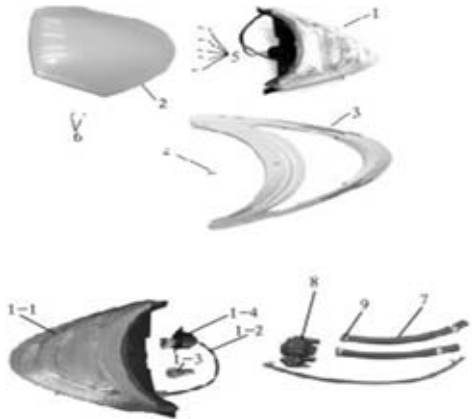

图18 方向把、操纵开关

Handlebar

型号 TOTAL NO	序号 NO	图号	零件编号 PQRT NO	英文名称 ENGLISH NAME
HS150T-3	1	82525-062-0000	150T3-12014	Handlebar front cover
HS150T-3	2	82526-062-0000	150T3-12015	Handlebar rear cover

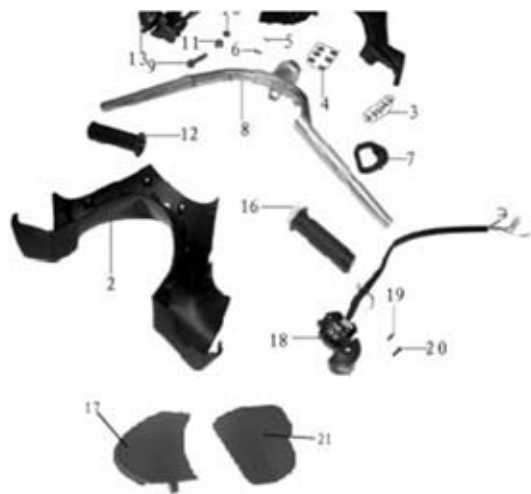

HS150T-3	3	845-4.8-16	GB845-85	self-tapping screw ST4.8×16
HS150T-3	4	90316-062-0000	125-T0010-001	clipΦ4. 8
HS150T-3	5	845-4.2-12	GB845-85	self-tapping screw ST4.2×12
HS150T-3	6	90503-062-0000	125-T0010-007	bolt M5×12
HS150T-3	7	82527-062-0000	150T3-27008	Rubber washer
HS150T-3	8	61101-062-0000	150T3-15002	Handlebar
HS150T-3	9	5787-10-50	GB/T5787-86	Hexagon bolt M10×50
HS150T-3	10	6187-10-00	GB/T6187-2000	Hexagon nut M10
HS150T-3	11	90208-062-0000	125-T0010-008	Handlebar lock cover
HS150T-3	12	43700-062-0000	150T3-27005	left handlebar grip
HS150T-3	13	37410-062-0100	150T3-25001	left switch assy
HS150T-3	16	43800-062-0000	150T3-27006	Right joystick assy
HS150T-3	17	82522-062-0000	150T3-12036	PROTECT COVER,LEFT HANDLEBAR
HS150T-3	18	37510-062-0300	150T3-25002	Accelerogracontrol handlebar
HS150T-3	21	82512-062-0000	150T3-12035	CoVER L.Brake



图19 仪表组合

Odometer assy

型号 TOTAL NO	序号 NO	图号	零件编号 PQRT NO	英文名称
				ENGLISH NAME
HS150T-3	1	36120-062-0200	150T3-24010	Odometer assy
HS150T-3	2	82521-062-0000	150T3-12016	Speedometer cover A
HS150T-3	3	36110-062-0000	150T3-15011	Speedometer rack
HS150T-3	4	6177-6-00	GB/T6177-2000	Hexagon bolt M6
HS150T-3	5	845-4.2-12	GB/T845-85	Selp-tapping screw ST4.2×12
HS150T-3	6	90316-062-0000	125-T0010-001	Clip ST4.8
HS150T-3	7	90601-062-0000	150T3-27003	Rubber washer
HS150T-3	8	845-4.8-16	GB/T845-85	Selp-tapping screw ST4.8×16
HS150T-3	9	54272-062-0000	150T3-15007	Cover brackt

图20 座垫总成

Cushion



型号 TOTAL NO	序号 NO	图号	零件编号 PQRT NO	英文名称
				ENGLISH NAME

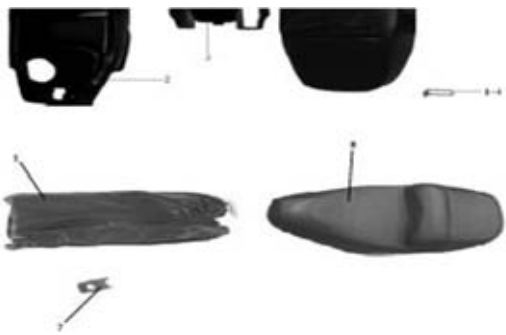

HS150T-3	1	85100-145-0000	125T-T0018	KIT SET
HS150T-3	2	82131-062-0000	150T3-12024	Cushion box
HS150T-3	3	82132-062-0000	150T3-12027	Cushion box cover
HS150T-3	4	818-6-16	GB/T818-2000	Bolt M6×16
HS150T-3	5	6177.1-6-00	GB/T6177.1-2000	Hexagon nut M6
HS150T-3	6	20.06.5787	GB/T5787-86	Hexagon nut M6×20
HS150T-3	7	90312-062-0000	125-T0010-010	Insert piece M6
HS150T-3	8	71100-062-0000	150T3-30010	Cushion



<b>图21 载物架</b>				
Rear carrier				
型号 TOTAL NO	序号 NO	图号	零件编号 PQRT NO	英文名称 ENGLISH NAME
HS150T-3	1	71401-062-0000	150T3-12034	Backrest rack
HS150T-3	2	16.08.5787	GB/T5787-86	Hexagon bolt M8×16
HS150T-3	3	71402-062-0000	150T3-30011	Backrest
HS150T-3	4	6187.1-6-00	GB/T6187.1-2000	Hexagon nut M6
HS150T-3	5	6187-8-00	GB/T6187-2000	Hexagon nut M8
HS150T-3	6	90209-062-0000	125-T0010-009	BUSH 8
HS150T-3	7	90102-062-0000	125-T0010-005	SETTNG SCREW M8×35REAR BRAKE
HS150T-3	8	90102-062-0000	125-T0010-005	SETTNG SCREW M8×50REAR BRAKE
HS150T-3	9	72711-062-0000	150T3-15017	Rear carrier

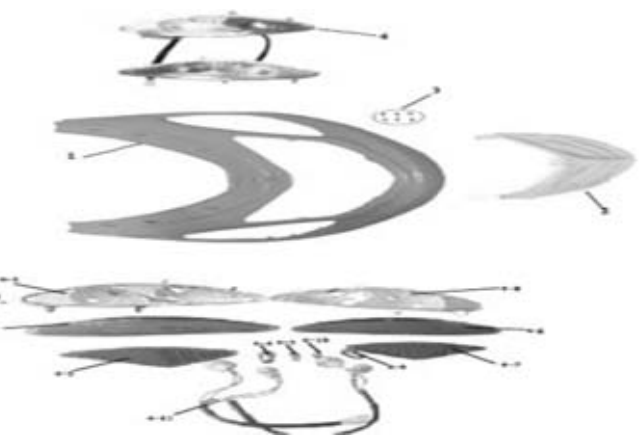

<b>图22 前围</b>				
Front boading				
型号 TOTAL NO	序号 NO	图号	零件编号 PQRT NO	英文名称 ENGLISH NAME
HS150T-3	1	82801-062-0000	150T3-12003	Front boading
HS150T-3	2	82806-062-0000	150T3-12004	Front decorate plate
HS150T-3	3	845-4.2-12	GB845-85	Selp-tapping screw ST4.2×12
HS150T-3	4	35710-062-0200	150T3-13030	Turning light assy

**图23 护条**

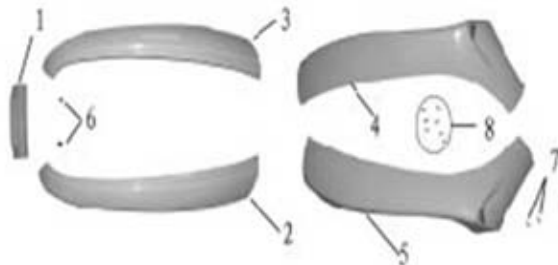

plastic plate				
型号 TOTAL NO	序号 NO	图号	零件编号 PQRT NO	英文名称 ENGLISH NAME
HS150T-3	1	83203-062-0000	150T3-12013	Rear plastic plate
HS150T-3	2	83201-062-0000	150T3-12011	Left plastic plate
HS150T-3	3	83202-062-0000	150T3-12012	Right plastic plate
HS150T-3	4	83205-062-0000	150T3-12009	Right front plastic plate
HS150T-3	5	83204-062-0000	150T3-12008	Left front plastic plate
HS150T-3	6	90316-062-0000	125-T0010-001	Clip ST4.8
HS150T-3	7	845-4.2-12	GB845-85	Selp-tapping screw ST4.2×12
HS150T-3	8	845-4.8-16	GB845-85	Selp-tapping screw ST4.8×16



图24 左、右装饰板 L、R decorate plate				
型号 TOTAL NO	序号 NO	图号	零件编号 PQRT NO	英文名称 ENGLISH NAME
HS150T-3	1	82211-062-0000	150T3-12007	Connect plate
HS150T-3	2	82301-062-0000	150T3-12005	Left decorate plate
HS150T-3	3	82401-062-0000	150T3-12006	Right decorate plate
HS150T-3	4	82133-062-0000	150T3-12025	Luggage box front cover
HS150T-3	5	82134-062-0000	150T3-12026	Maintain cover
HS150T-3	6	82742-062-0000	150T3-12022	Side board of left footboard
HS150T-3	7	82743-062-0000	150T3-12023	Side board of right footboard
HS150T-3	8	845-4.8-16	GB/T845-85	Selp-tapping screw ST4.8×16
HS150T-3	9	90316-062-0000	125-T0010-001	Clip ST4.8
HS150T-3	10	845-4.2-16	GB/T845-85	Selp-tapping screw ST4.2×16



图25 脚踏底板 Footboard				
型号 TOTAL NO	序号 NO	图号	零件编号 PQRT NO	英文名称 ENGLISH NAME
HS150T-3	1	82731-062-0000	150T3-12021	Footboard
HS150T-3	2	82141-062-0000	150T3-12017	Frame front fender
HS150T-3	3	82144-062-0000	150T3-12019	Helmet hook



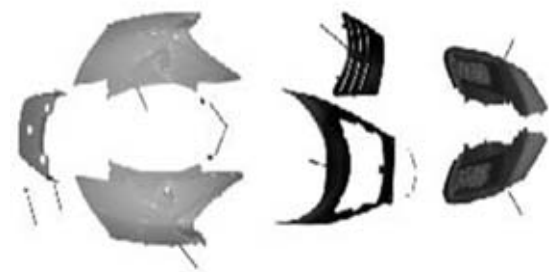
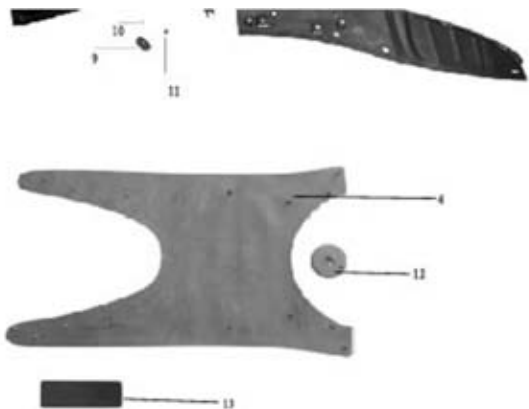

HS150T-3	4	82735-062-0000	150T3-27004	FOOT PEDAL FUR
HS150T-3	5	90104-062-0000	125-T0010-003	Hexagon bolt M6×18×14
HS150T-3	6	82732-062-0000	150T3-12029	Battery cover
HS150T-3	7	845-4.2-16	GB845-85	Self-tapping screw 4.2×16
HS150T-3	8	90316-062-0000	125-T0010-001	Clip ST4.8
HS150T-3	9	34821-145-0200	150T3-14002	Ventro-reflector
HS150T-3	10	6187-6-00	GB/T6187-2000	Hexagon nut M6
HS150T-3	11	90305-062-0000	125-T0010-002	Nut M6
HS150T-3	12	82152-062-0000	150T3-12037	WATER CAP COVER
HS150T-3	13	82143-062-0000	150T3-12018	VIN NUMBER COVER

图26 后尾灯组合

Taillight assy

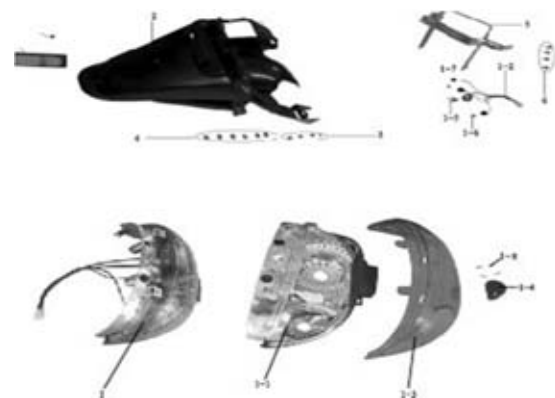

型号 TOTAL NO	序号 NO	图号	零件编号 PQRT NO	英文名称 ENGLISH NAME
HS50T-2	1	35200-062-0200	150T3-13020	v
HS150T-3	2	82203-062-0200	150T3-12033	RELAY
HS150T-3	3	6177-6-00	GB/T6177-2000	BATTARY
HS150T-3	4	90316-062-0000	125-T0010-001	HARDNEES WIRE
HS150T-3	5	54209-062-0000	150T3-15008	SIDE WIRE
HS150T-3	6	16.06.5787	GB/T5787-86	GROUND WIRE .A
HS150T-3	7	34841-145-0200	150T3-14001	GROUND WIRE .B
HS150T-3	8	6177-5-00	GB/T6177-2000	POWER WIRE

图27 油箱总成

Fuel tank

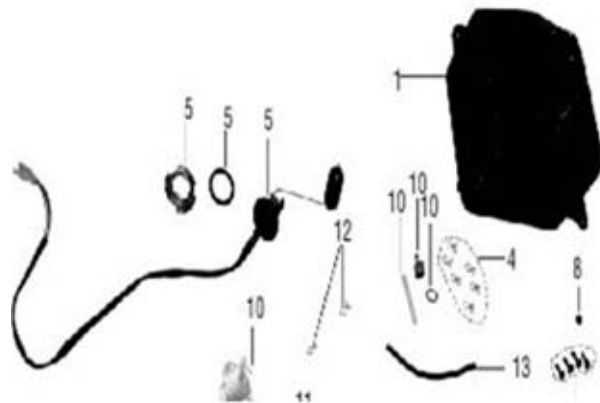

型号 TOTAL NO	序号 NO	图号	零件编号 PQRT NO	英文名称 ENGLISH NAME
HS150T-3	1	81101-062-0000	150T3-22001	Fuel tank
HS150T-3	2	81301-062-0000	150T3-22002	Fuel tank cover
HS150T-3	3	16501-145-0000	125T-T0012	Oil pipe Φ8×4
HS150T-3	4	90402-145-0000	125T-T0014	Clip Φ8×1
HS150T-3	5	36211-062-0000	150T3-24020-001	Fuel sensor
HS150T-3	6	36212-062-0000	150T3-24020-002	WASHER FUEL SENSOP UNIT

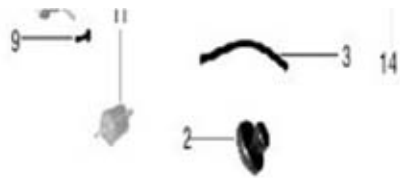

HS150T-3	7	36213-062-0000	150T3-24020-003	PLATE FUEL SEBSOR UNIT
HS150T-3	8	5787-6-00	GB/T5787-86	Hexagon nut M6
HS150T-3	9	16.06.5787	GB/T5787-86	Hexagon bolt M6×16
HS150T-3	10	81410-060-0000	125T-T0031	Fuel switch
HS150T-3	11	16610-145-0000	125T-T0032	Oil filter
HS150T-3	12	90401-145-0000	125T-T0013	Clip Φ7×1
HS150T-3	13	16507-145-0000	125T-T0011	Gas hose Φ7×3
HS150T-3	14	12.06.5787	GB/T5787-86	Hexagon bolt M6×12

图28 锁类

ALL LOCKS



型号 TOTAL NO	序号 NO	图号	零件编号 PQRT NO	英文名称
				ENGLISH NAME
HS150T-3	1	85700-062-0000	150T3-26010	ALL LOCKS
HS150T-3	1-2	85719-062-0000	150T3-15023	Bracket ignition cock
HS150T-3	1-5	85717-062-0000	150T3-15024	Bracket of seat lock
HS150T-3	2	16.08.5787	GB/T5787-86	Hexagon bolt M8×16
HS150T-3	3	90502-062-0000	125-T0010-006	Bolt M6×8
HS150T-3	4	12.06.5787	GB/T5787-86	Hexagon bolt M6×12

图29 挡泥板

FRAME FENDER

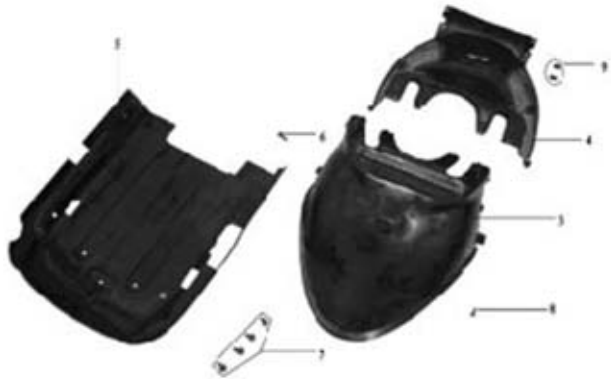

型号 TOTAL NO	序号 NO	图号	零件编号 PQRT NO	英文名称
				ENGLISH NAME
HS150T-3	1	19871-145-0000	125T-T0026	VENT-PIPE
HS150T-3	2	19872-145-0000	125T-T0027	VENT-PIPE HOOP
HS150T-3	3	82171-062-0000	150T3-12031	FRONT , FRONT WHEEL FENDER
HS150T-3	4	82172-062-0000	150T3-12032	REAR.FRONT WHEE FENDER
HS150T-3	5	82802-062-0000	150T3-12028	FRAME FENDER
HS150T-3	6	16.06.5787	GB/T5787-86	HEXSGON BOLT M6×16
HS150T-3	7	12.06.5787	GB/T5787-86	HEXSGON BOLT M6×12
HS150T-3	8	845-4.2-16	GB845-85	ELF-TAPPING SCREW ST4.2×16
HS150T-3	9	90316-062-0000	125-T0010-001	CLIP ST4.8

图30 电器电缆组成

## WIRE ASSY

型号 TOTAL NO	序号 NO	图号	零件编号 PQRT NO	英文名称
				ENGLISH NAME
HS150T-3	1-1	34110-062-0000	150T3-23010	HARDNEES WIRE
HS150T-3	1-2	34101-062-0000	150T3-23013	“-”CABLE
HS150T-3	1-3	34101-062-0000	150T3-23014	“-”CABLE
HS150T-3	1-4	34102-062-0000	150T3-23012	“+”CABLE
HS150T-3	2	33201-145-0000	125T-T0004	CDI ASSY
HS150T-3	3	33100-145-0000	125T-T0005	HIGH VOLTAGE WIRE ASSY
HS150T-3	4	32101-145-0000	125T-T0007	RECTIFIER ASSY
HS150T-3	5	37710-145-0000	125T-T0006	RELAY ASSY
HS150T-3	6	34600-145-0000	125T-T0002	FLASHER
HS150T-3	7	34500-060-0200	125T-T0003	HORN ASSY
HS150T-3	8	32200-145-0000	125T-T0008	BATTARY
HS150T-3	9	91524-145-0000	125T-T0009	BELT
HS150T-3	10	12.06.5787	GB/T/T5787-86	HEXANGON BOLT M6×12
HS150T-3	11	20.06.5787	GB/T/T5787-86	HEXANGON BOLT M6×20



图31 前轮组合

## RIM FRONT WHEEL

型号 TOTAL NO	序号 NO	图号	零件编号 PQRT NO	英文名称
				ENGLISH NAME
HS150T-3	1	41110-145-0100	150T3-17010	RIM FRONT WHEEL
HS150T-3	2	41160-145-0100	150T3-18001	tire
HS150T-3	3	44100-062-0200	150T3-34010	Disk control
HS150T-3	4	44102-145-0000	150T3-34021	Brake disk
HS150T-3	5	90102-062-0000	150T-34010-016	SEAR SCREW, BRAKE DISK
HS150T-3	6	25.08.5787	GB/T5787-86	BOLT M 8×25
HS150T-3	7	5787-12-235	GB/T5787-86	Front axleM12×235
HS150T-3	8	6187-12-00	GB6187-2000	Hexagon nut m12
HS150T-3	9	90207-062-0000	125-T0010-004	Bushing Φ20×25
HS150T-3	10	36510-145-0000	150T3-20010	COUNTER



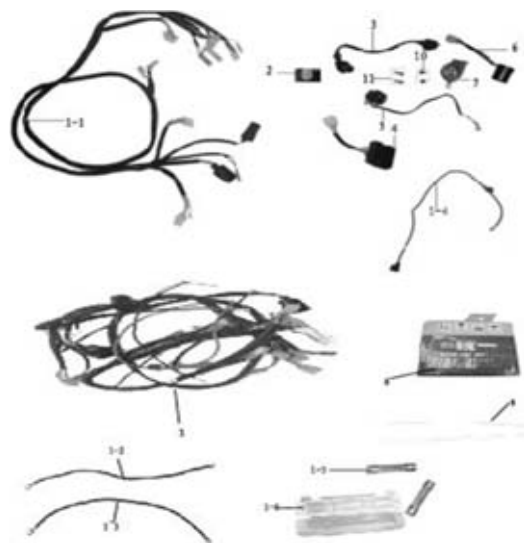
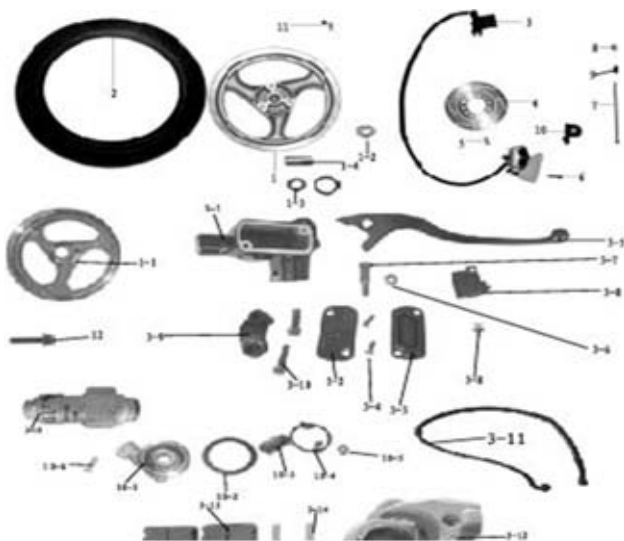

HS150T-3	11	41120-145-0000	150T3-18002	VALVE
HS150T-3	12	30.08.5787	GB/T5787-86	Hexagon bolt M8×30

图32 前叉总成

Steering column

型号 TOTAL NO	序号 NO	图号	零件编号 PQRT NO	英文名称
				ENGLISH NAME
HS150T-3	1	82173-062-0000	150T3-12039	FR. MUOGUARO, WHEEL
HS150T-3	2	62121-062-0200	150T3-15003	Steering column
HS150T-3	3	62127-062-0000	150T3-16007	Lock nut
HS150T-3	4	62128-062-0000	150T3-16006	Under cover,bearing bowel
HS150T-3	5	62122-062-0000	150T3-16001	Upper cover bearing bowel
HS150T-3	6	62123-062-0000	150T3-16002	Upper cover bearing race
HS150T-3	7	62125-062-0000	150T3-16003	Upper ball
HS150T-3	8	62126-062-0000	150T3-16004	Under ball
HS150T-3	9	62124-062-0000	150T3-16005	Linder cover bearing race
HS150T-3	10	55310-062-0200	150T3-19010	Left absorber assy
HS150T-3	11	5787-10-40	GB/T5787-86	Hexagon bole M10×40
HS150T-3	12	55351-062-0000	150T3-19023	Locker card
HS150T-3	13	12.06.6187	GB/T6187-86	Hexagon bolt M6×12
HS150T-3	14	55340-062-0200	150T3-19020	Right absorber assy
HS150T-3	15	44101-062-0000	150T3-19022	Clip oil cable



图33 操纵线

Throttle cable

型号 TOTAL NO	序号 NO	图号	零件编号 PQRT NO	英文名称
				ENGLISH NAME
HS150T-3	1	34900-145-0000	125T-T0030	BURGLERY DEFENDER
HS150T-3	2	61500-062-0000	150T3-28001	Throttle cable
HS150T-3	3	71130-062-0000	150T3-28002	Seat lock cable
HS150T-3	4	36330-062-0000	150T3-28003	Speedometer cable hose
HS150T-3	5	43200-062-0200	150T3-28004	Rear brake cable



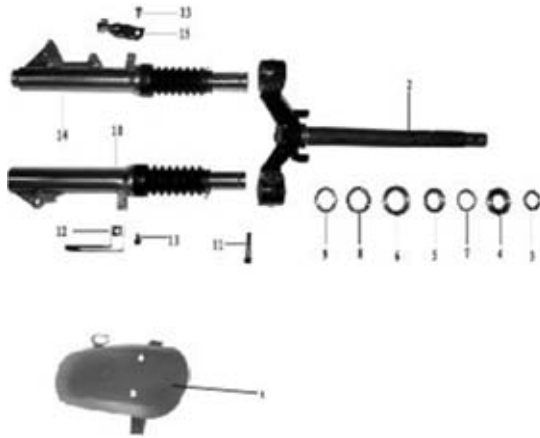

图34 车架部件

## Frame assy

型号 TOTAL NO	序号 NO	图号	零件编号 PQRT NO	英文名称
				ENGLISH NAME
HS150T-3	1	51101-062-0200	150T3-15001	Frame assy
HS150T-3	2	54501-062-0200	150T3-15004	Side stand
HS150T-3	3	91403-060-0000	150T3-29001	Spring of side stand
HS150T-3	4	90104-062-0000	125-T0010-003	Bole of side stand
HS150T-3	5	54301-062-0000	150T3-15006	Hanger
HS150T-3	6	5787-10-55	GB/T5787-2000	Hexagon bolt M10×55
HS150T-3	7	5787-10-184	GB/T5787-86	Hexagon bolt M10×184
HS150T-3	8	6187-10-00	GB/T6187-2000	Hexagon nut M10
HS150T-3	9	54311-145-0000	150T3-27001	Buffer of hanger
HS150T-3	10	54401-062-0200	150T3-15005	Center stand
HS150T-3	11	91405-060-0000	150T3-29002	Spring of center stand
HS150T-3	12	5787-10-25	GB/T5787-86	Hexagon bolt M10×25
HS150T-3	13	90209-062-0000	125-T0010-009	BUSH?10.5×15×9
HS150T-3	14	54402-062-0000	150T3-27002	Buffer of center stand
HS150T-3	15	5787-6-25	GB/T5787-86	Hexagon bolt M6×25
HS150T-3	16	6177.1-6-00	GB/T6177.1-2000	Hexagon nut M6
HS150T-3	17	54220-062-0000	150T3-15009	Brake,footboard
HS150T-3	18	37220-145-0000	125T-T0001	Side stand flameout switch
HS150T-3	19	818-6-16	GB/T818-88	BOLT M6×16
HS150T-3	20	43501-062-0000	150T3-15012	Footrest,rear brake
HS150T-3	21	43502-062-0000	150T3-27007	CUSHION RUBBER PIECES,REAR BRAKE
HS150T-3	22	43503-062-0001	125T-T0050	slide-proof plate,rear brake
HS150T-3	23	6177.1-5-00	GB/T6177.1-2000	nut M5
HS150T-3	24	90504-062-0000	125-T0010-006	BOLT M5X16
HS150T-3	25	37660-062-0000	150T3-25003	Lock,rear brake
HS150T-3	26	34831-145-0200	125-T14002	VENTRO-REFLECTOR
HS150T-3	27	90207-062-0000	125-T0010-004	BUSH Φ9×?16×30
HS150T-3	28	92114-145-0200	125T-T0025	NAMEPLATE
HS150T-3	29	37603-062-0000	150T3-29003	Spring,rear brake

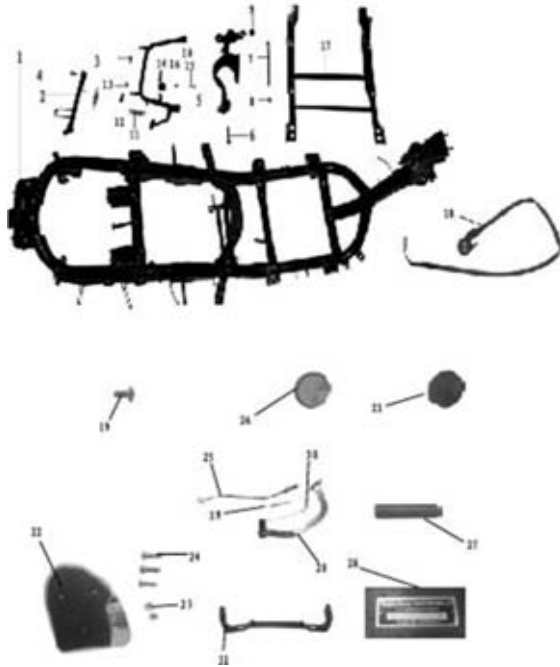

HS150T-3	30	37602-062-0000	150T3-29004	Lock spring,rear brake
HS150T-3	31	54211-062-0100	150T3-15022	Holder Nameplate

图35 消声器

Muffler assy



型号 TOTAL NO	序号 NO	图号	零件编号 PQRT NO	英文名称 ENGLISH NAME
HS150T-3	1	18120-062-0200	150T3-21010	Muffler assy
HS150T-3	2	18112-062-0000	150T3-21010-005	MUFFLER AIRPROOF PAD
HS150T-3	3	5787-8-55	GB/T5787-86	Hexagon bolt M8×55
HS150T-3	4	5787-8-80	GB/T5787-86	Hexagon bolt M8×80
HS150T-3	5	90305-062-0000	125-T0010-002	NUT M6×30

图36 后轮总成

Rear wheel



型号 TOTAL NO	序号 NO	图号	零件编号 PQRT NO	英文名称 ENGLISH NAME
HS150T-3	1	55510-062-0200	150T3-19021	Rear absorber assy
HS150T-3	2	5787-8-32	GB/T5787-2000	Hexagon bolt M8×32
HS150T-3	3	5787-10-40	GB/T5787-86	Hexagon bolt M10×40
HS150T-3	4	6187-10-00	GB/T6187-2000	Hexagon nut M10
HS150T-3	5	18303-062-0100	150T3-15014	Connecting plate
HS150T-3	6	90207-062-0000	150T3-15015	Bushing AΦ17×Φ25×7
HS150T-3	7	90207-062-0000	150T3-15016	Bushing BΦ17×Φ25×33
HS150T-3	8	6187-16-00	GB/T6187-2000	Hexagon nut M16
HS150T-3	9	41210-145-0100	150T3-17011	Rear wheel
HS150T-3	10	41160-145-0100	150T3-18001	Rear wire
HS150T-3	11	41120-145-0000	150T3-18002	Valve stem
HS150T-3	12	82201-062-0200	150T3-12038	Rear wheel fender
HS150T-3	13	54204-145-0000	150T3-15018	Right bracket
HS150T-3	14	54203-145-0000	150T3-15019	Left bracket
HS150T-3	15	16.06.5787	GB/T5787-86	HExagon bolt M6×16



